

# HFA105NH60R

HEXFRED™

Ultrafast, Soft Recovery Diode

## Features

- Reduced RFI and EMI
- Reduced Snubbing
- Extensive Characterization of Recovery Parameters

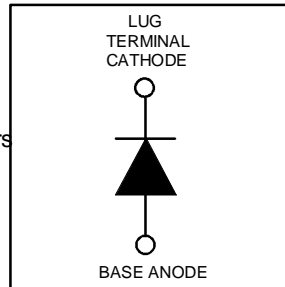

$V_R = 600V$
$V_F = 1.5V$
$Q_{rr}^* = 1200nC$
$di_{(rec)M}/dt^* = 240A/\mu s$
* 125°C

## Description

HEXFRED™ diodes are optimized to reduce losses and EMI/RFI in high frequency power conditioning systems. An extensive characterization of the recovery behavior for different values of current, temperature and di/dt simplifies the calculations of losses in the operating conditions. The softness of the recovery eliminates the need for a snubber in most applications. These devices are ideally suited for power converters, motors drives and other applications where switching losses are significant portion of the total losses.

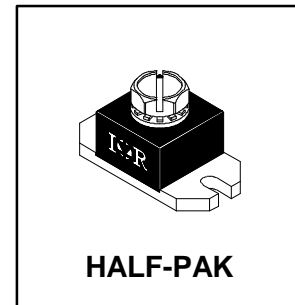

## Absolute Maximum Ratings

	Parameter	Max.	Units
$V_R$	Cathode-to-Anode Voltage	600	V
$I_F @ T_C = 25^\circ C$	Continuous Forward Current	147	A
$I_F @ T_C = 100^\circ C$	Continuous Forward Current	72	
$I_{FSM}$	Single Pulse Forward Current ①	600	
$I_{AS}$	Maximum Single Pulse Avalanche Current ②	2.0	
$E_{AS}$	Non-Repetitive Avalanche Energy ②	220	$\mu J$
$P_D @ T_C = 25^\circ C$	Maximum Power Dissipation	379	W
$P_D @ T_C = 100^\circ C$	Maximum Power Dissipation	152	
$T_J$ $T_{STG}$	Operating Junction and Storage Temperature Range	-55 to +150	°C

## Thermal - Mechanical Characteristics

	Parameter	Min.	Typ.	Max.	Units
$R_{\theta JC}$	Junction-to-Case, Single	—	—	0.33	°C/W
$R_{\theta CS}$	Case-to-Sink, Flat, Greased Surface	—	0.15	—	K/W
$Wt$	Weight	—	26 (0.9)	—	g (oz)
	Mounting Torque	15 (1.7)	—	25 (2.8)	lbf•in
	Terminal Torque	20 (2.2)	—	40 (4.4)	(N•m)

**Note:** ① Limited by junction temperature  
② L = 100 $\mu$ H, duty cycle limited by max  $T_J$

# HFA105NH60R



## Electrical Characteristics @ $T_J = 25^\circ\text{C}$ (unless otherwise specified)

	Parameter	Min.	Typ.	Max.	Units	Test Conditions
$V_{BR}$	Cathode Anode Breakdown Voltage	600	—	—	V	$I_R = 100\mu\text{A}$
$V_{FM}$	Max Forward Voltage	—	1.3	1.5	V	$I_F = 105\text{A}$
			1.5	1.7		$I_F = 210\text{A}$
			1.2	1.4		$I_F = 105\text{A}, T_J = 125^\circ\text{C}$
$I_{RM}$	Max Reverse Leakage Current	—	6.0	30	$\mu\text{A}$	$V_R = V_R \text{ Rated}$
			1.5	6.0		$T_J = 125^\circ\text{C}, V_R = 480\text{V}$
$C_T$	Junction Capacitance	—	200	300	pF	$V_R = 200\text{V}$
$L_S$	Series Inductance	—	6.0	—	nH	From top of terminal hole to mounting plane

## Dynamic Recovery Characteristics @ $T_J = 25^\circ\text{C}$ (unless otherwise specified)

	Parameter	Min.	Typ.	Max.	Units	Test Conditions
$t_{rr}$	Reverse Recovery Time	—	35	—	ns	$I_F = 1.0\text{A}, di_F/dt = 200\text{A}/\mu\text{s}, V_R = 30\text{V}$
$t_{rr1}$			90	140		$T_J = 25^\circ\text{C}$
$t_{rr2}$			160	240		$T_J = 125^\circ\text{C}$
$I_{RRM1}$	Peak Recovery Current	—	10	18	A	$T_J = 25^\circ\text{C}$
$I_{RRM2}$			15	30		$T_J = 125^\circ\text{C}$
$Q_{rr1}$	Reverse Recovery Charge	—	450	1300	nC	$T_J = 25^\circ\text{C}$
$Q_{rr2}$			1200	3600		$T_J = 125^\circ\text{C}$
$di_{(rec)M}/dt1$	Peak Rate of Fall of Recovery Current During $t_b$	—	310	—	A/ $\mu\text{s}$	$T_J = 25^\circ\text{C}$
$di_{(rec)M}/dt2$			240	—		$T_J = 125^\circ\text{C}$

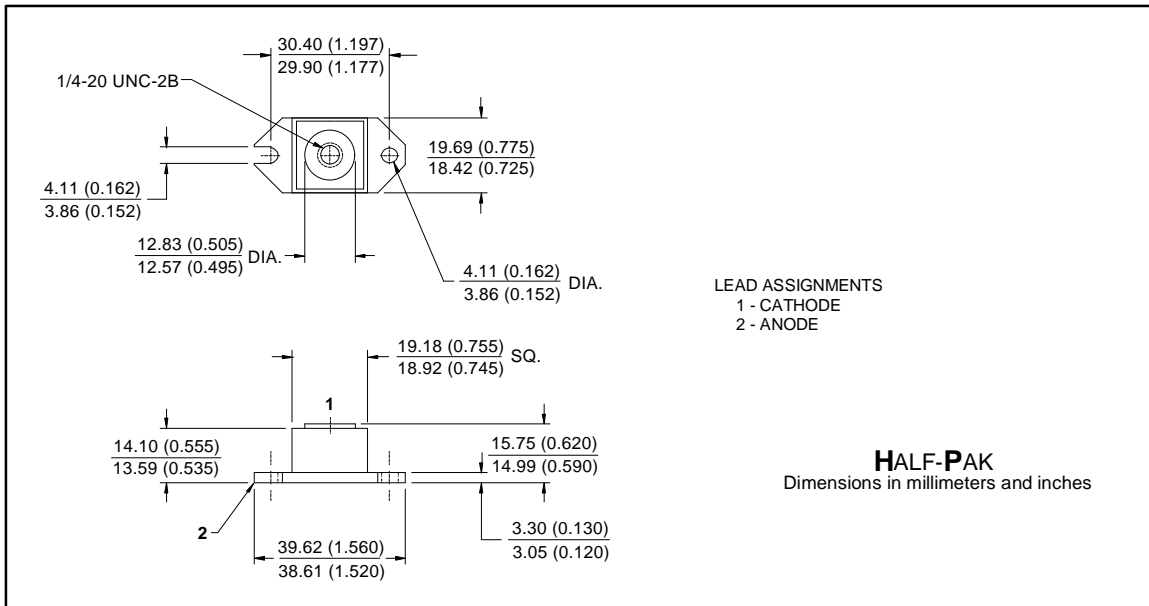



# HFA105NH60R

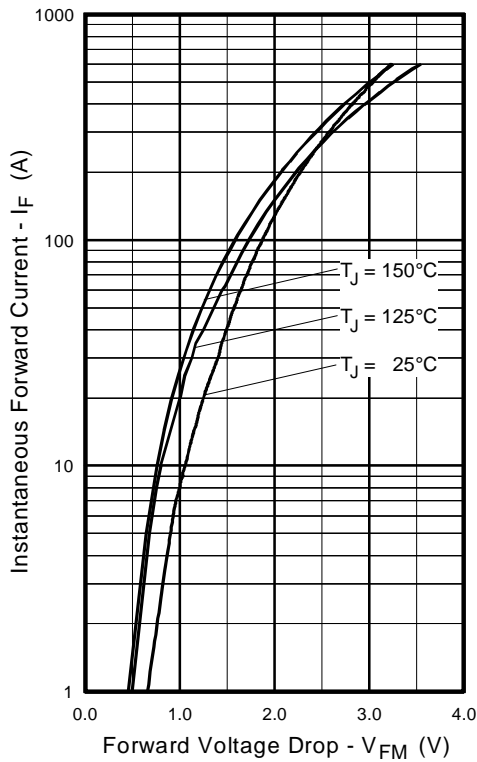

**Fig. 1 - Maximum Forward Voltage Drop vs. Instantaneous Forward Current**

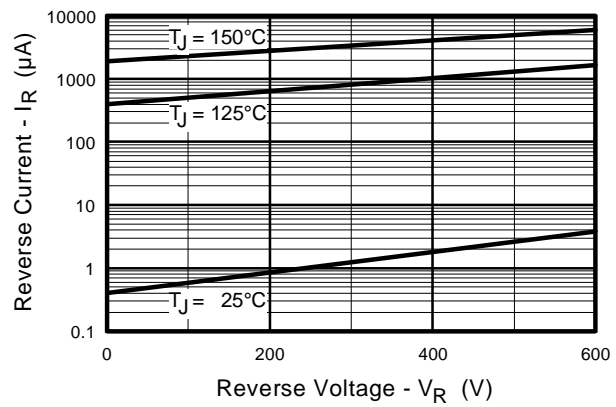

**Fig. 2 - Typical Reverse Current vs. Reverse Voltage**

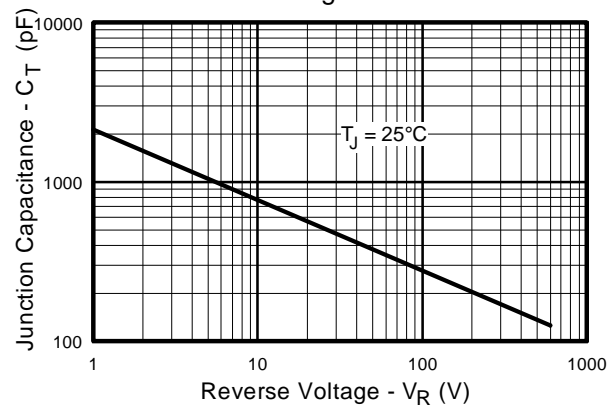

**Fig. 3 - Typical Junction Capacitance vs. Reverse Voltage**

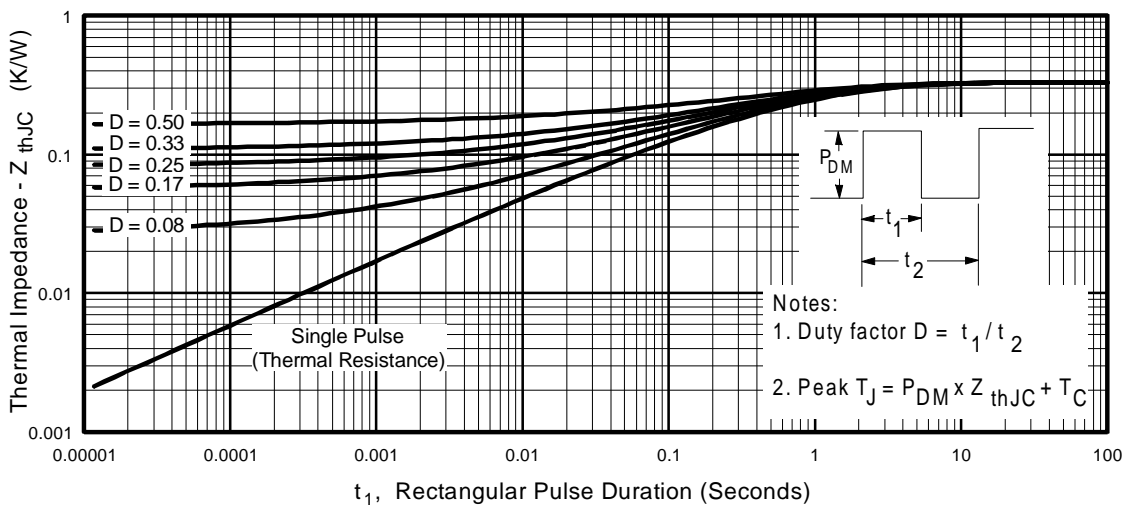

**Fig. 4 - Maximum Thermal Impedance  $Z_{thJC}$  Characteristics**

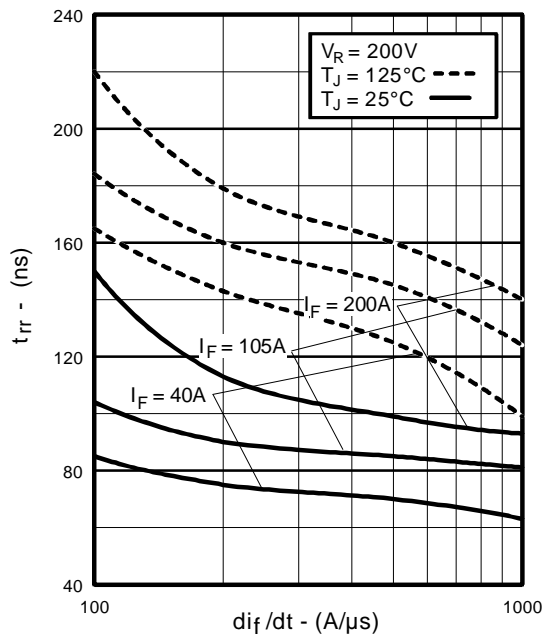

**Fig. 5 - Typical Reverse Recovery vs.  $dI/dt$**

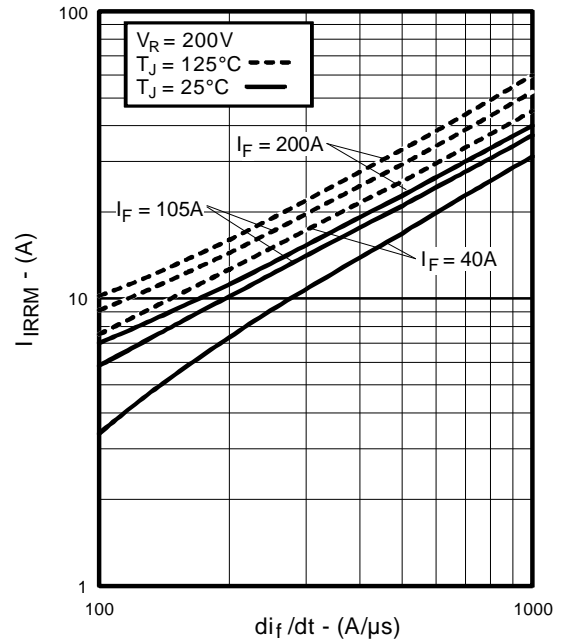

**Fig. 6 - Typical Recovery Current vs.  $dI/dt$**

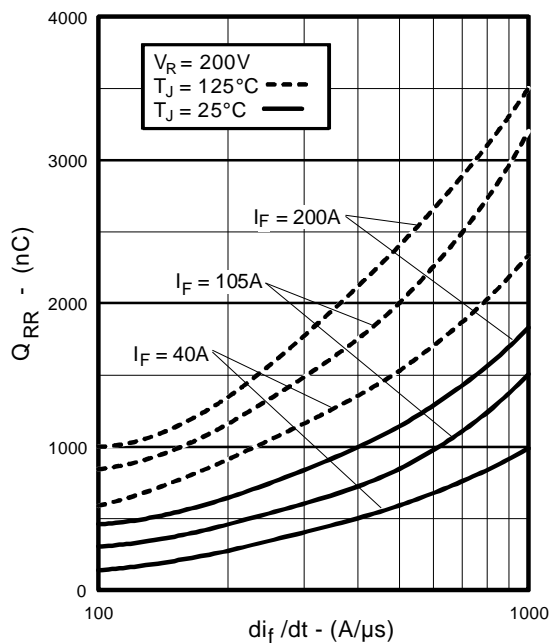

**Fig. 7 - Typical Stored Charge vs.  $dI/dt$**

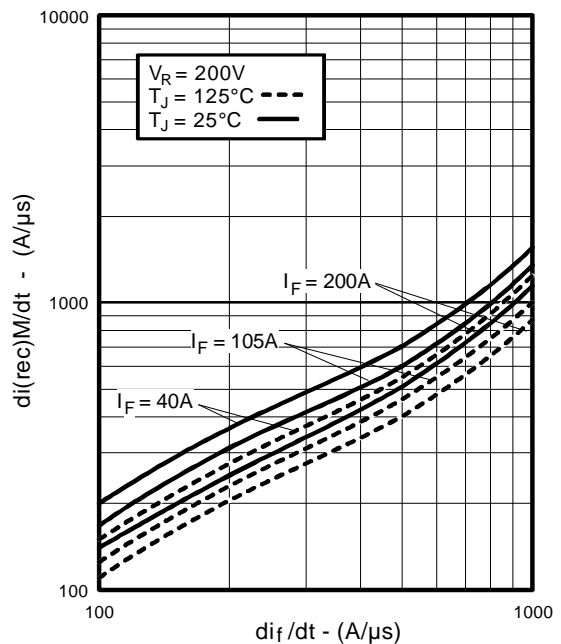

**Fig. 8 - Typical  $dI_{(rec)M}/dt$  vs.  $dI/dt$**

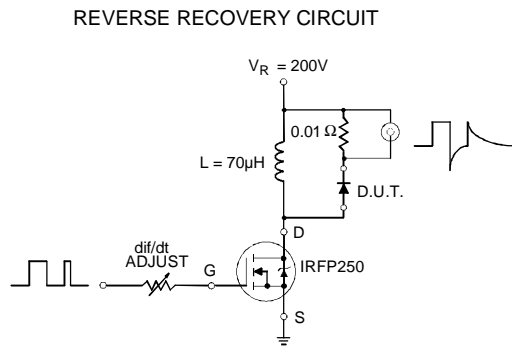

**Fig. 9 - Reverse Recovery Parameter Test Circuit**

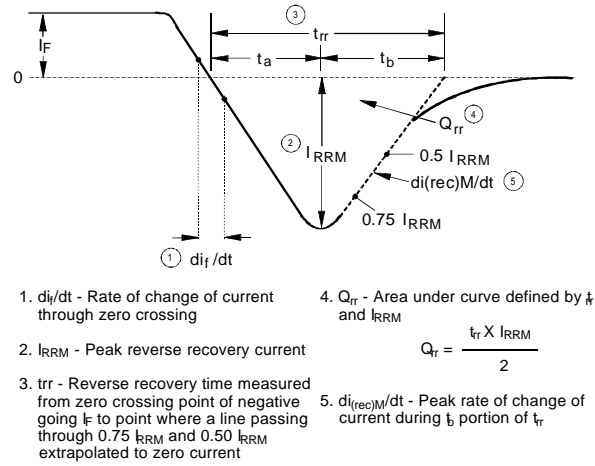

**Fig. 10 - Reverse Recovery Waveform and Definitions**

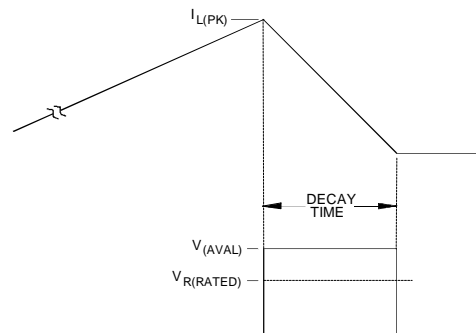
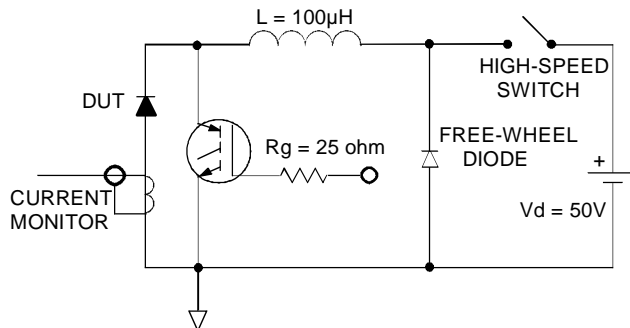

**Fig. 11 - Avalanche Test Circuit and Waveforms**